

Silicon PNP Power Transistors

2SA1493

DESCRIPTION

- With MT-200 package
- Complement to type 2SC3857

APPLICATIONS

- Audio and general purpose

PINNING(see Fig.2)

PIN	DESCRIPTION
1	Base
2	Collector;connected to mounting base
3	Emitter

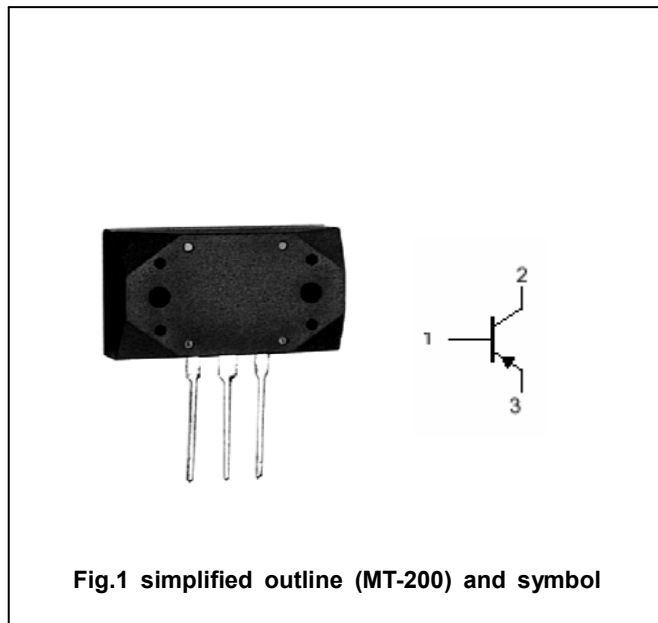

Fig.1 simplified outline (MT-200) and symbol

Absolute maximum ratings (Ta=25℃)

SYMBOL	PARAMETER	CONDITIONS	VALUE	UNIT
V_{CBO}	Collector-base voltage	Open emitter	-200	V
V_{CEO}	Collector-emitter voltage	Open base	-200	V
V_{EBO}	Emitter-base voltage	Open collector	-6	V
I_C	Collector current		-15	A
I_B	Base current		-5	A
P_C	Collector power dissipation	$T_C=25^\circ\text{C}$	150	W
T_j	Junction temperature		150	℃
T_{stg}	Storage temperature		-55~150	℃

Silicon PNP Power Transistors

2SA1493

CHARACTERISTICS

T_j=25 °C unless otherwise specified

SYMBOL	PARAMETER	CONDITIONS	MIN	TYP.	MAX	UNIT
V _{(BR)CEO}	Collector-emitter breakdown voltage	I _C =-50mA; I _B =0	-200			V
V _{CEsat}	Collector-emitter saturation voltage	I _C =-10 A; I _B =-1 A			-3.0	V
I _{CBO}	Collector cut-off current	V _{CB} =-200V; I _E =0			-100	μA
I _{EBO}	Emitter cut-off current	V _{EB} =-6V; I _C =0			-100	μA
h _{FE}	DC current gain	I _C =-5A ; V _{CE} =-4V	50		180	
f _T	Transition frequency	I _C =-0.5A ; V _{CE} =-12V		20		MHz
C _{OB}	Output capacitance	I _E =0; V _{CB} =-10V; f=1MHz		400		pF

Switching times

t _{on}	Turn-on time	I _C =-5A; R _L =-12Ω I _{B1} =-I _{B2} =-0.5A V _{CC} =-60V		0.30		μs
t _s	Storage time			0.90		μs
t _f	Fall time			0.20		μs

◆ h_{FE} classifications

O	P	Y
50-100	70-140	90-180

Silicon PNP Power Transistors

2SA1493

PACKAGE OUTLINE

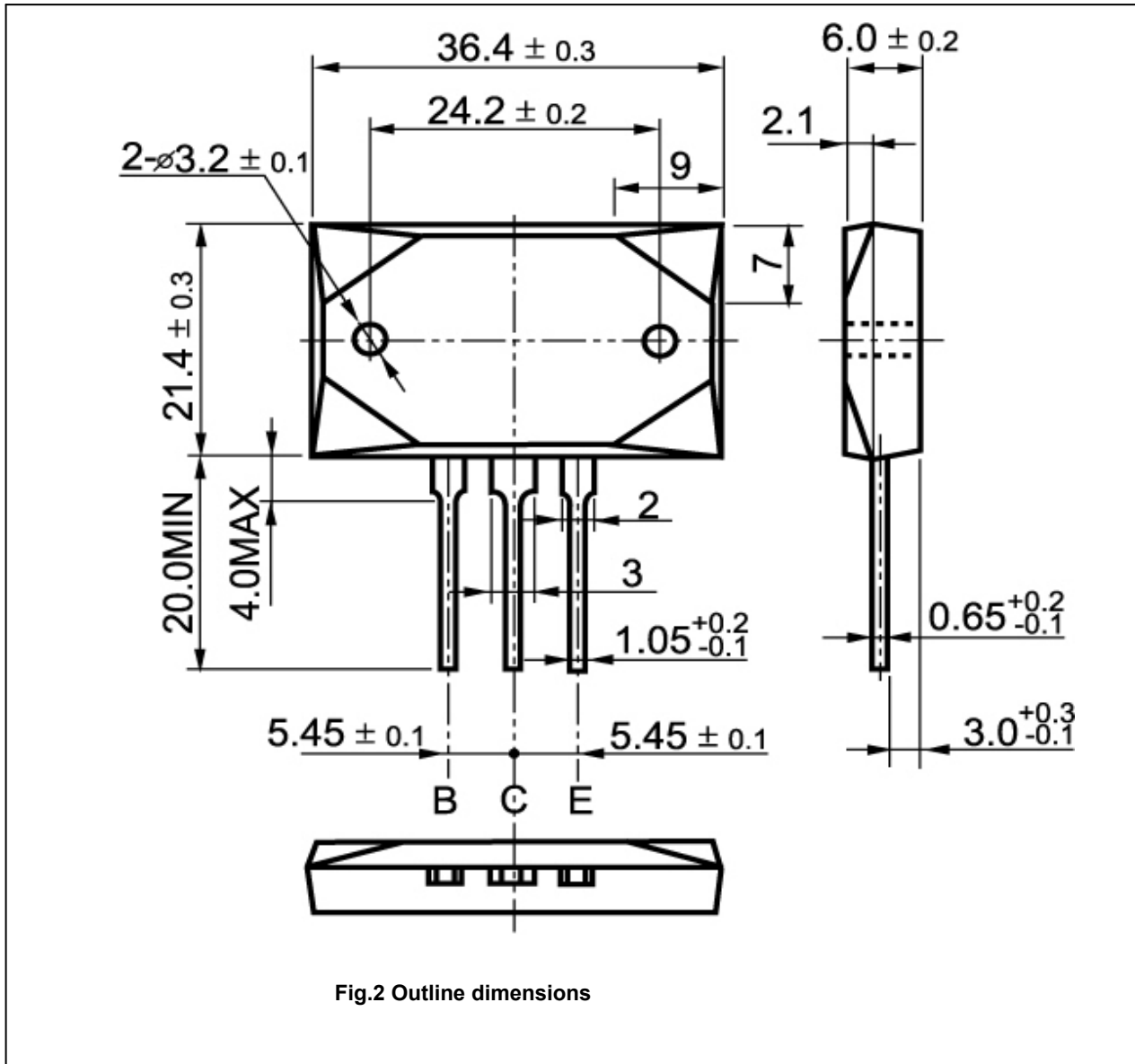

Silicon PNP Power Transistors

2SA1493

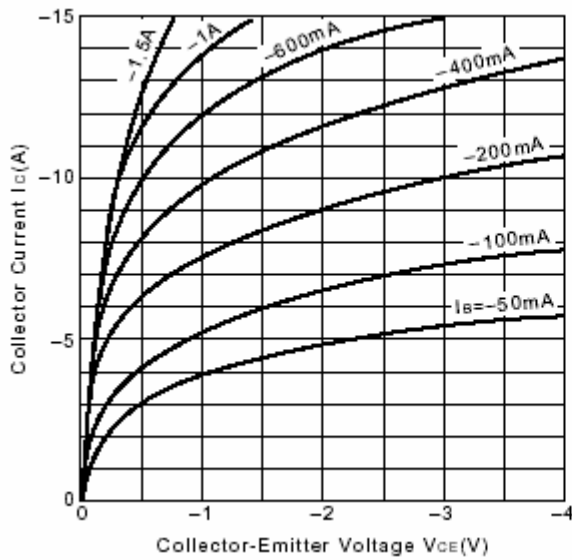

Fig.3 Static Characteristic

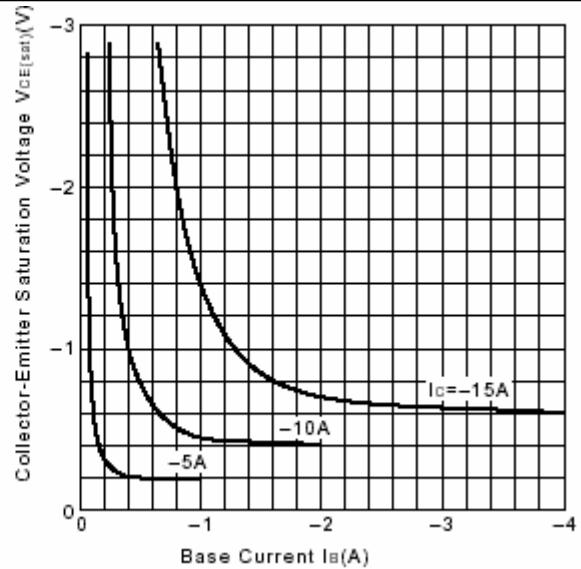

Fig.4 $V_{CE(sat)}$ - I_B Characteristics

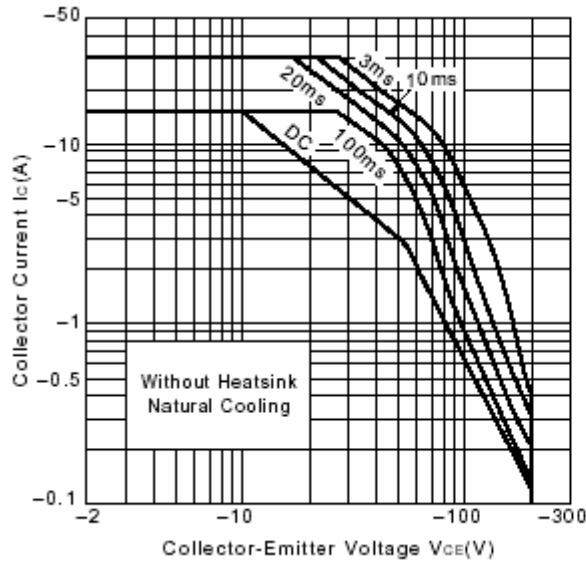

Fig.5 Safe Operating Area

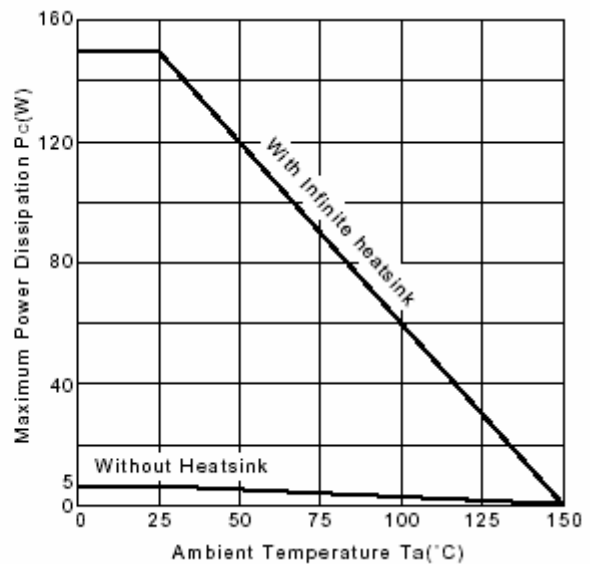

Fig.6 P_c - T_a Derating

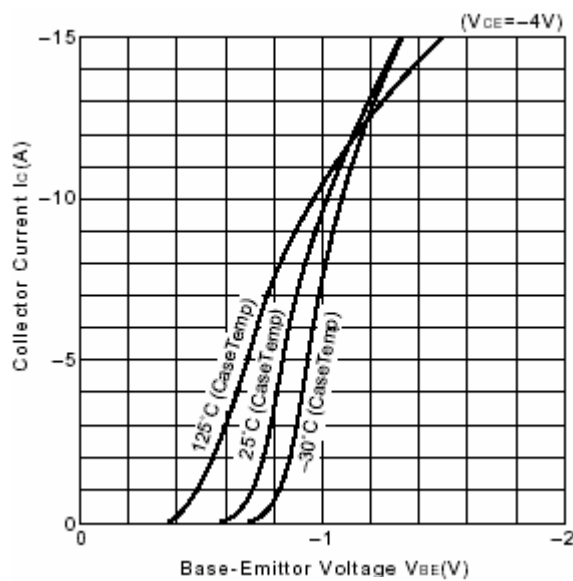

Fig.7 I_C - V_{BE}

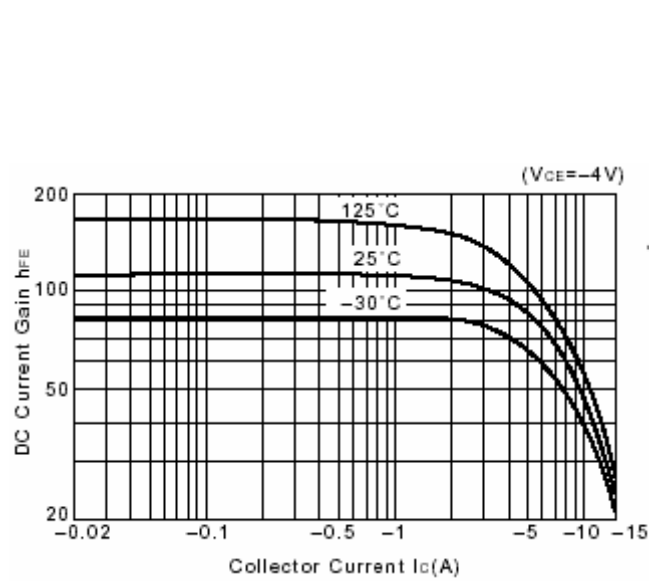

Fig.8 DC current Gain